

Vacuum Pumps and Generators



VB Series Regenerative Pump VB10HV



Features:

- Cooler running, outboard bearing provides virtually maintenance-free operation in continuous duty service.
- Environmentally friendly oil-free design prevents downstream contamination of gas or components.
- Quiet operation; as low as 73 dB(A)
- Standard TEFC with Class F insulation, UL recognized, CE Compliant motors.

Performance curve for Vacuum pump

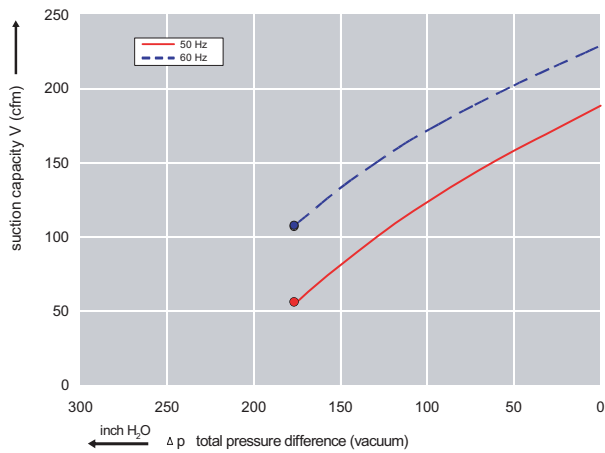

Performance curve for Compressor

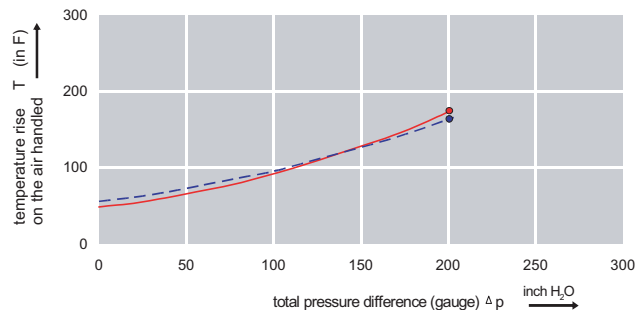
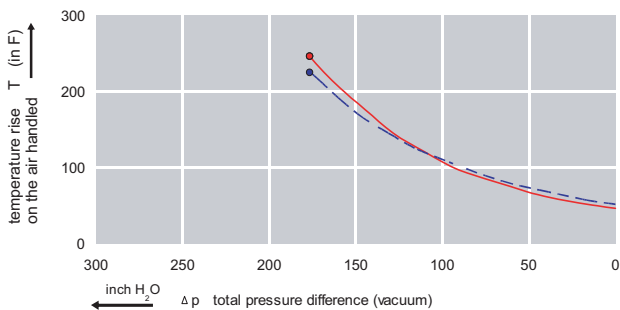
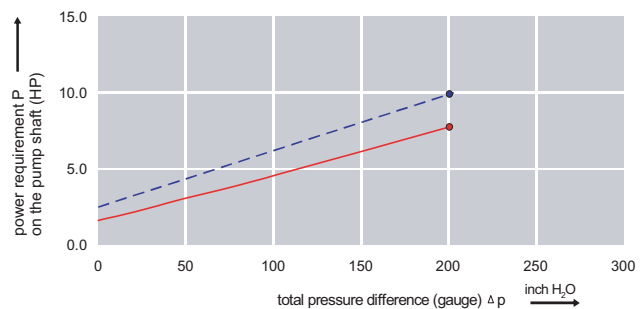
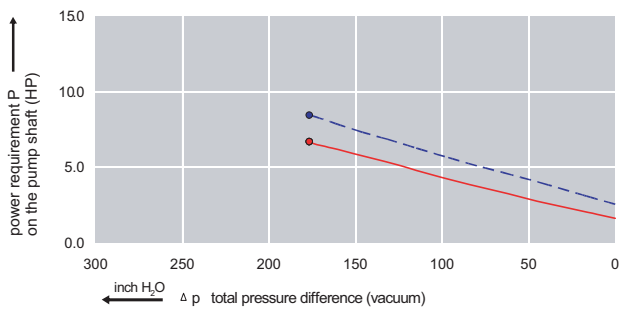
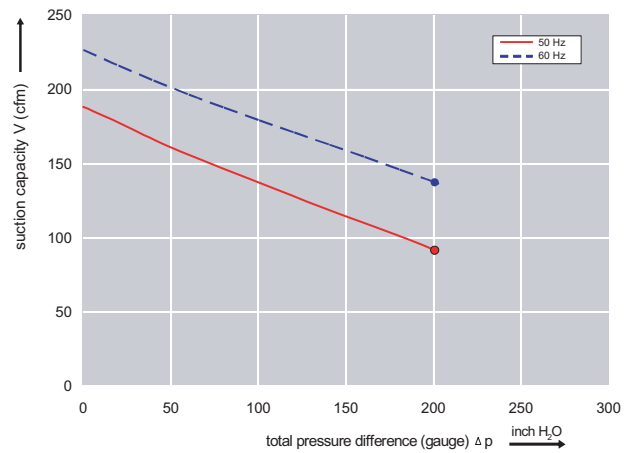

➔ This spec sheet was adapted for print from our website. Additional information and photos are available at www.anver.com. 6090901

VB Series Regenerative Pump VB10HV

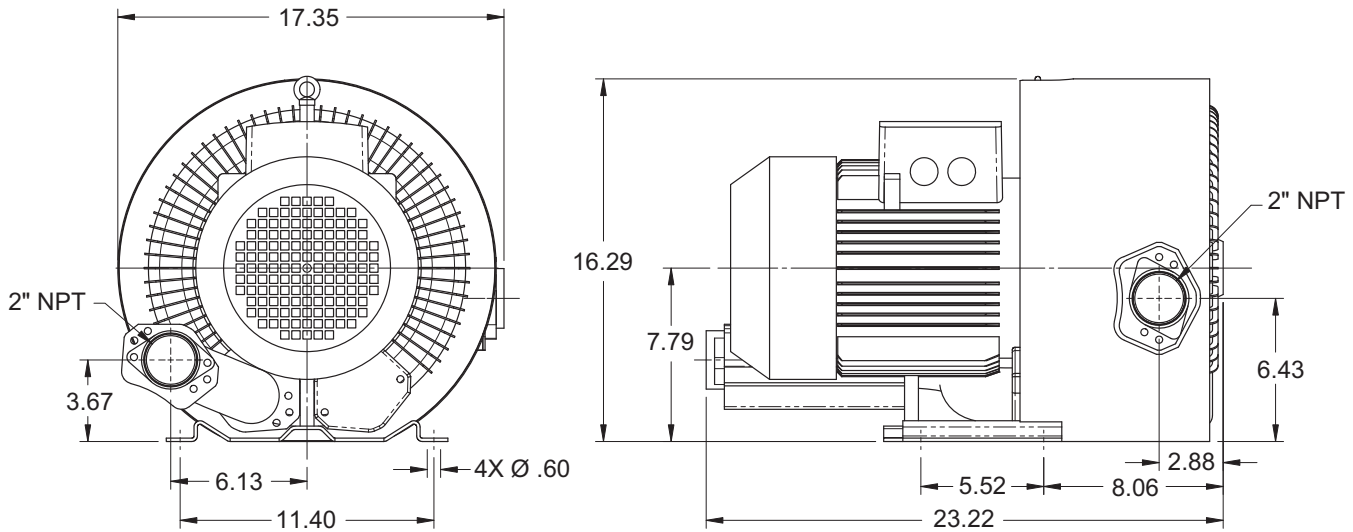

Hz	Voltage Range	Rated Amps	Rated HP	Maximum Vacuum in H ₂ O mbar	Maximum Pressure in H ₂ O mbar	Maximum Flow CFM m ³ h	Net Weight lb kg
60	220-250/415-460	20.0/11.2	8.5	180 (448)	200 (498)	225 (380)	154 (70)
50	200-240/345-415	23.0/13.3	7.4	180 (448)	200 (498)	190 (320)	154 (70)

NOTES:

A) Performance tolerance is ±10%.

B) Performance curves are based on an air temperature of 60° F (15° C) at the inlet connection and 29.92 Hg abs (1013 mbar) at the discharge connection.

Due to the nature of constantly changing electric motors and pumps, specifications are subject to change without notice.

Also available as explosion proof and wash down. Consult factory for more information.